

POS-NR.	DESCRIPTION	MATERIAL	QTY
1	front plate for SUB-D 44 pin female	Al2O3	1
2	Crimp Pin 0.7mm	Copper Alloy Gold plated	44
3	back plate for SUB-D 44 Pin	AL2O3	1
4	Countersunk Screw M2X10	Stainless Steel	3
5	Hexagon Nut M2 DIN934	Stainless Steel	2
6	Slotted Cheese Screw 4-40 UNC	1.4301 (X5CrNi18-10)	2

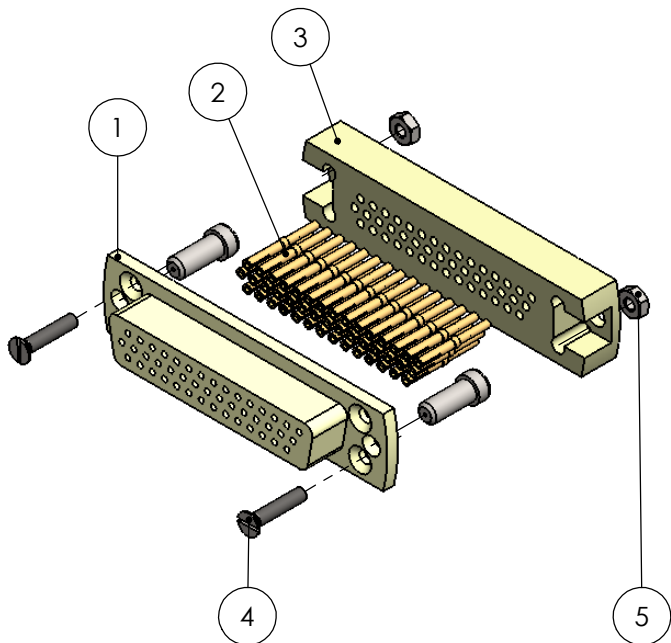
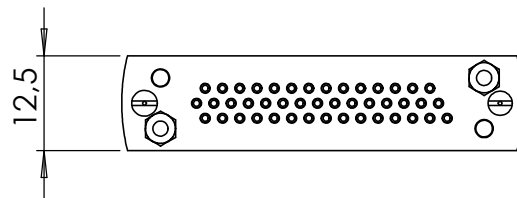
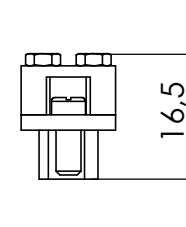
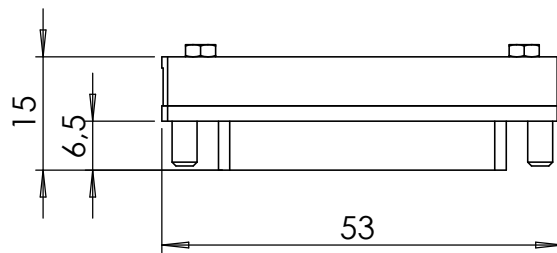
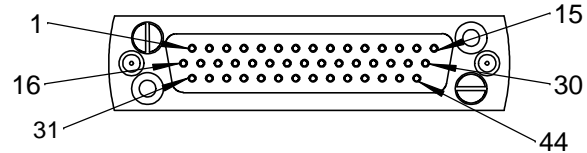

Bemerkungen  
(Remarks)

All informations provided in this drawing is considered to be confidential, proprietary and secret information. It is intended only for the use of individual or entity to whom it is sent. Individual or entity agrees to not disseminate or copy this information to anyone other than originally specified without the written consent Alletra GmbH.

Freimaßtoleranz  
(Standard Toleranz)

Maßstab  
(Scale)

1:1

Rauheit (Roughness)

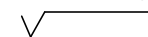

europ.Projektion

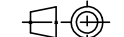

Kanten (edges)

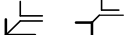

Material, Standard  
Oberfläche  
(Treatment)

Bezeichnung  
(Title)

**UHV connector 44 Pin female  
high density SUB-D**

Gewicht  
(weight)

g

30.38

Page: Pages:

2

2

Zeichnungsnummer  
(Drawing No.)

**211-FS44H-UHV**

Revision



Datei (File) C:\PDMStore\C\PDMStore\

Format **A4**

Index	Modification	Datum	Name