

|   |   |                         |             |                 |
|---|---|-------------------------|-------------|-----------------|
|  | DOCUMENT NAME   |                         | VERSION     | <b>UI32395A</b> |
|   | <b>Operating and Maintenance Handbook - Rotary Drives<br/>RD9, RD91, RD91MG, RD91SB, RD93, RD932, RD93K,<br/>RD93P, RD94 RD942, RD94K</b> |                         | 1.1         |                 |
|   | FILE NAME   | REVISED DATE & INITIALS | REPLACEMENT | CLASSIFICATION  |
| UI32395A  | May 1995 MJD  | -                       |             |                 |
| APPROVED BY   | DATE  | PREPARED BY             | DATE        | PAGE            |
|   | -   | MJD                     | May 1995    | 1 2             |

# Operating and Maintenance Handbook

## Rotary Drives RD9, RD91, RD91MG, RD91SB, RD93, RD932, RD93K, RD93P, RD94, RD942, RD94K



| REVISION | DATE     | COMMENTS         | INITIALS |
|----------|----------|------------------|----------|
| 1        | May 1995 | Original release | MJD      |
|          |          |                  |          |
|          |          |                  |          |
|          |          |                  |          |

Copyright Notice 2002 by VACGEN. All rights reserved. Information contained in this handbook is subject to change without notice and does not represent a commitment on the part of VACGEN. No part of this document may be copied or distributed, transmitted, transcribed, stored in a retrieval system or translated into any human or computer language, in any form or by any means, electronic, mechanical, magnetic, optical, manual or otherwise or disclosed to third parties without the express written permission of

|  |   |              |                         |          |                 |
|--|---|--------------|-------------------------|----------|-----------------|
| <br><b>VACGEN</b> | DOCUMENT NAME   |              |                         | VERSION  | <b>UI32395A</b> |
|  | <b>Operating and Maintenance Handbook - Rotary Drives<br/> RD9, RD91, RD91MG, RD91SB, RD93, RD932, RD93K,<br/> RD93P, RD94 RD942, RD94K</b> |              |                         | 1.1      |                 |
|  | FILE NAME   |              | REVISED DATE & INITIALS |          | REPLACEMENT     |
| UI32395A   |   | May 1995 MJD |                         | -        |                 |
| APPROVED BY  |   | DATE         | PREPARED BY             | DATE     | PAGE            |
|  |   | -            | MJD                     | May 1995 | 22              |

## Contents

### 1.0 Introduction to the RD9 Family of Rotary Drives

### 2.0 The RD91 Rotary Drive

#### 2.1 Specification

#### 2.2 Construction

#### 2.3 Bakeout

##### 2.3.1 Bakeout up to 250°C

##### 2.3.2 High Temperature Bakeout from 250°C to 400°C

#### 2.4 Maintenance

### 3.0 The RD91M Rotary Drive

#### 3.1 Specification

#### 3.2 Construction

#### 3.3 Operation

#### 3.4 Bakeout

##### 3.4.1 Bakeout to 250°C

##### 3.4.2 High Temperature Bakeout to 400°C

#### 3.5 Maintenance

### 4.0 The RD9 1 MG Rotary Drive with 5: 1 Reduction Gearbox

#### 4.1 Specification

#### 4.2 Construction

#### 4.3 Operation

#### 4.4 Bakeout

##### 4.4.1 Bakeout to 250°C

##### 4.4.2 High Temperature Bakeout to 400°C

#### 4.5 Maintenance

### 5.0 RD93 Miniature Rotary Drive

#### 5.1 Specification

#### 5.2 Construction

#### 5.3 Operation

### 6.0 RD94 Miniature Rotary Drive with Graduated Handwheel 13

#### 6.1 Specification

#### 6.2 Construction

#### 6.3 Operation

### 7.0 Spares and Accessories

#### 7.1 The RD91 Friction Brake Accessory - RD91 SB

##### 7.1.1 Fitting the Friction Brake to the RD91 Rotary Drive

|  |   |              |                         |      |         |                 |
|--|---|--------------|-------------------------|------|---------|-----------------|
| <br><b>VACGEN</b> | DOCUMENT NAME   |              |                         |      | VERSION | <b>UI32395A</b> |
|  | <b>Operating and Maintenance Handbook - Rotary Drives<br/>RD9, RD91, RD91MG, RD91SB, RD93, RD932, RD93K,<br/>RD93P, RD94 RD942, RD94K</b> |              |                         |      | 1.1     |                 |
|  | FILE NAME   |              | REVISED DATE & INITIALS |      | REPLACE |                 |
| UI32395A   |   | May 1995 MJD |                         | -    |         |                 |
| APPROVED BY  | DATE  | PREPARED BY  | DATE                    | PAGE |         |                 |
|  | -   | MJD          | May 1995                | 32   |         |                 |

## WARRANTY

1. Subject to fair wear and tear and the due observance of any installation user, storage, operating or maintenance instructions the Seller undertakes to replace or, at its option repair free of charge to the purchaser, any goods which the purchaser can establish are defective by reason of defective workmanship or materials which are returned to the Seller, carriage paid, within 12 months of the date of dispatch by the Seller. In the event, however, that the Seller supplies spare parts either direct, or that are fitted or installed or replaced by the Sellers' service center such spare parts will be subject to a warranty period of six months only.
2. The Purchaser cannot return any product for warranty repair without the prior approval of VACGEN and the issue of a Goods Return Number (GRN). This shall be obtained by contacting the service center at VACGEN. All returned products must be accompanied by a completed Declaration of Contamination form. Customers must, in the first instance, contact the local selling agent.
3. We reserve the right to decline to service equipment, we consider is in any way hazardous until a clearance or safety certificate, in a form satisfactory to VACGEN, has been completed and returned by the customer.

## REPAIR

The following additional terms and conditions apply in the event that the customer elects to use the services of VACGEN workshop on a chargeable basis.

1. At its own cost the customer shall dispatch the equipment to the workshop, carriage paid, suitably packaged, protected and insured, bearing, a Goods Return Number (GRN) and a completed Declaration of Contamination certificate obtained from VACGEN in advance of shipment.
2. During the period that the equipment is on VACGEN premises, VACGEN will insure the equipment against all risks.
3. Vacuum Generator will provide an acknowledgement of the receipt together with an estimate of the repair charges. Such estimates are carried out on a visual basis and are therefore intended as a guide only. Formal fixed price repair quotations are available and involve the disassembly of the equipment to determine the full extent of the work necessary to restore the equipment to an acceptable standard. In the event that the customer chooses not to proceed with the repair VACGEN will make a charge to cover this examination effort.

Note:

The above are extracts from VACGEN Conditions of sale. Complete copies can be obtained from:

VACGEN, Diamond Drive, Hailsham, BN27 4EL, UK – 01323 379335

|   |   |                         |          |                 |                |
|---|---|-------------------------|----------|-----------------|----------------|
|  | DOCUMENT NAME   |                         | VERSION  | <b>UI32395A</b> |                |
|   | <b>Operating and Maintenance Handbook - Rotary Drives<br/>RD9, RD91, RD91MG, RD91SB, RD93, RD932, RD93K,<br/>RD93P, RD94 RD942, RD94K</b> |                         | 1.1      |                 |                |
|   | FILE NAME   | REVISED DATE & INITIALS |          | REPLACEMENT     | CLASSIFICATION |
| UI32395A  | May 1995 MJD  |                         | -        |                 |                |
| APPROVED BY   | DATE  | PREPARED BY             | DATE     | PAGE            |                |
|   | -   | MJD                     | May 1995 | 42              |                |

## 1.0 Introduction to the RD9 - Family of Rotary Drives

The RD9 family of rotary drives are suitable for low torque applications such as high speed shutter or chopper drives or in-vacuum transfer and transport devices. A range of drives exist to suit many different requirements.

The **RD91** is a manual drive fitted with a 5° calibrated handwheel with a 1° vernier scale; the handwheel has an integral belt drive groove. This drive has been designed for high precision use. The RD91 M is a dedicated motor driven version with direct stepper motor drive; the RD91 cannot be upgraded to the RD91M version. The RD91MG is another variant which has a 5:1 inline gearbox built onto the rotary drive. The RD91 Series drives are mounted on 34mm OD knife-edge flanges. A friction brake accessory, the RD91SB, is also available for the manual drive (see section 7).

The **RD93** is a small, compact, drive designed for long life and minimal maintenance; it is supplied for hand operation. The handwheel is not graduated and has a locking screw; it can easily be removed for direct coupling to a drive system. The RD93 is available on 34mm and 70mm OD knife-edge flanges and on a KF25 Klein fitting. The in-vacuum shaft is 4.75mm (0.187") diameter.

The **RD94** is similar in design to the RD93, but is capable of higher rotation speeds and has a 511 graduated handwheel with locking screw. The mounting flange is a 34mm OD knife edge flange; 70mm OD knife edge flange and KF25 Klein fitting variants are also available.

## 2.0 The RD91 Rotary Drive

### 2.1 Specification

|                     |  |
|---------------------|--|
| Speed               | 500rpm maximum   |
| Torque              | 0.125 Nm maximum at 500rpm, 0.5Nm maximum at 10rpm         |
| Thrust              | 10N maximum, axial and radial                              |
| Pressure Range      | Atmosphere to 10 <sup>-11</sup> mbar                       |
| Bakeout Temperature | 250°C maximum without dismantling, 400°C after disassembly |
| Mounting Flange     | 34mm OD  |
| Angular Range       | 360° continuous  |
| Angular Resolution  | 1°   |

|   |   |              |                         |      |             |                 |
|---|---|--------------|-------------------------|------|-------------|-----------------|
|  | DOCUMENT NAME   |              |                         |      | VERSION     | <b>UI32395A</b> |
|   | <b>Operating and Maintenance Handbook - Rotary Drives<br/>RD9, RD91, RD91MG, RD91SB, RD93, RD932, RD93K,<br/>RD93P, RD94 RD942, RD94K</b> |              |                         |      | 1.1         |                 |
|   | FILE NAME   |              | REVISED DATE & INITIALS |      | REPLACEMENT |                 |
| UI32395A  |   | May 1995 MJD |                         | -    |             |                 |
| APPROVED BY   | DATE  | PREPARED BY  | DATE                    | PAGE |             |                 |
|   | -   | MJD          | May 1995                | 52   |             |                 |

## 2.2 Construction

The vacuum envelope of the RD91 family of drives is of stainless steel construction which incorporates a metal bellows and wobble drive which are designed for operation in high or ultra-high vacuum environments.

The RD91 has an anodised aluminium handwheel graduated in 50 divisions, a position lock and a 1° vernier scale are fitted as standard (see figure 1).

## 2.3 Bakeout

### 2.3.1 Bakeout up to 250°C

The RD91 may be baked at temperatures up to 250°C without any dismantling. Ensure that the position lock is released before bakeout. After bakeout, allow the drive to cool for at least a further 6 hours after the external housing has reached room temperature before operating. The in-vacuum components cool slowly and may be damaged if operated whilst still hot.

### 2.3.2 High Temperature Bakeout from 250°C to 400°C

Prior to bakeout at temperatures between 250°C and 400°C, some disassembly of the rotary drive is required.

Note:

In order to retain the orientation of the shaft with respect to the handwheel it is necessary that the position lock screw ring, the stainless steel bearing housing beneath it, and the stainless steel flange body all retain their relative orientations to one another. This can be achieved by scribing a line across all three adjoining end faces before dismantling the drive. The three components should be re-aligned on reassembly.

Disassemble as follows:

- 1) Mark a line (if required) as described in the note above.
- 2) Unscrew (3 turns) the three M4 radial grub screws that secure the position lock/ vernier ring to the bearing housing. Move the ring toward the vacuum flange.
- 3) Unscrew (3 turns) the three M4 radial grub screws (now visible) that secure the handwheel bearing assembly to the stainless steel body.
- 4) Ease the handwheel bearing assembly from the drive unit. Note the handwheel orientation relative to the bellows bearing offset.

|   |   |                         |          |                 |
|---|---|-------------------------|----------|-----------------|
|  | DOCUMENT NAME   |                         | VERSION  | <b>UI32395A</b> |
|   | <b>Operating and Maintenance Handbook - Rotary Drives<br/>RD9, RD91, RD91MG, RD91SB, RD93, RD932, RD93K,<br/>RD93P, RD94 RD942, RD94K</b> |                         | 1.1      |                 |
|   | FILE NAME   | REVISED DATE & INITIALS |          | REPLACE         |
| UI32395A  | May 1995 MJD  |                         | -        |                 |
| APPROVED BY   | DATE  | PREPARED BY             | DATE     | PAGE            |
|   | -   | MJD                     | May 1995 | 62              |

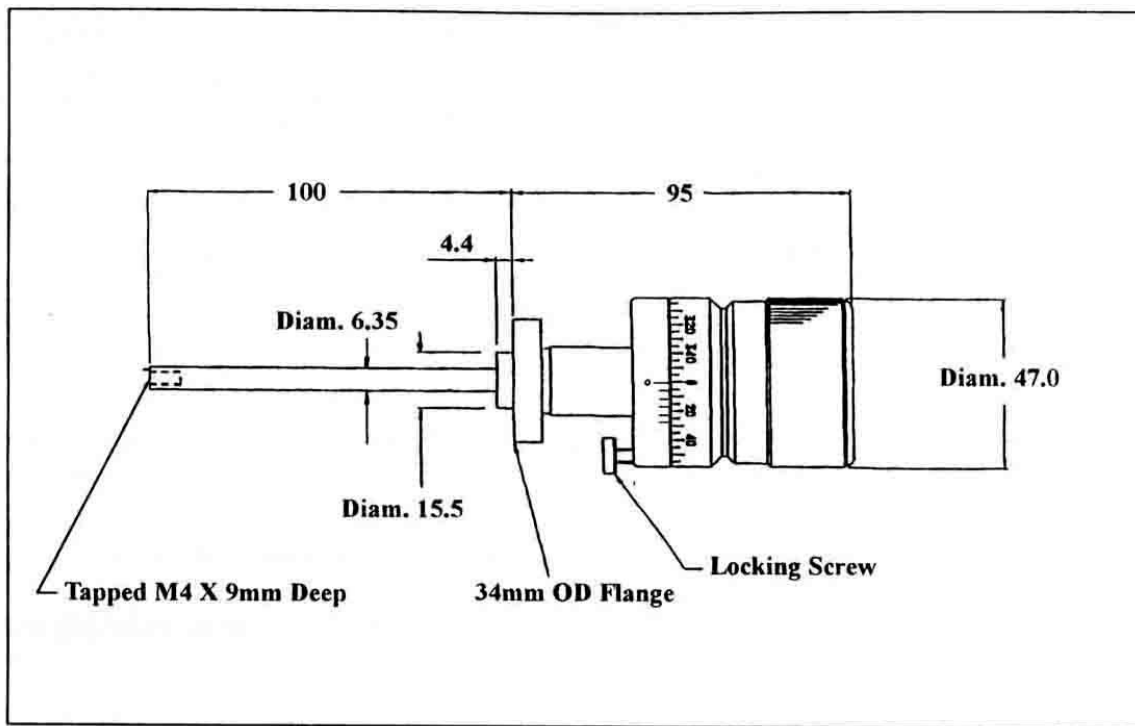

**Figure 1 - The RD91 rotary drive**

- 5) Remove the position lock ring completely from the drive.
- 6) Remove the circlip and the bearing from the bellows end.
- 7) The drive is now ready for bakeout up to 400°C maximum.

After bakeout, reassemble as follows:

- 8) The bellows end must be at room temperature before reassembly (see section 2.3.1)
- 9) Reassemble the drive following the reverse procedure of items 1) to 6) described above. During reassemble the user should note the following:
  - a) The handwheel orientation relative to the bellows offset should be the same as before removal.
  - b) The items should be assembled with care, and must not be forced together.
  - c) Ensure that the grub screws do not protrude into the bore of the components before refitting the handwheel bearing assembly or the position lock ring.
  - d) Insert the position lock ring over the body before fitting the handwheel assembly.
  - e) Align the scribed line on the stainless steel housing with that on the flange body.
  - f) Do not use excessive force when tightening the grub screws.

|   |   |              |                         |         |                 |
|---|---|--------------|-------------------------|---------|-----------------|
|  | DOCUMENT NAME   |              |                         | VERSION | <b>UI32395A</b> |
|   | <b>Operating and Maintenance Handbook - Rotary Drives<br/>RD9, RD91, RD91MG, RD91SB, RD93, RD932, RD93K,<br/>RD93P, RD94 RD942, RD94K</b> |              |                         | 1.1     |                 |
|   | FILE NAME   |              | REVISED DATE & INITIALS |         | REPLACEMENT     |
| UI32395A  |   | May 1995 MJD |                         | -       |                 |
| APPROVED BY   | DATE  | PREPARED BY  | DATE                    | PAGE    |                 |
|   | -   | MJD          | May 1995                | 72      |                 |

g) Align the scribed line on the position lock end face with that on the stainless steel bearing housing.

## 2.4 Maintenance

After repeated or extended bakeout some loss of rotational freedom may occur. This may indicate that the in-atmosphere bearings are in need of re-lubrication. To relubricate, proceed as follows:

- 1) Disassemble as if for high temperature bakeout as described in section 2.3.
- 2) Use Carbaflo lubricant (supplied in the ZHPTSLK lubrication kit) to relubricate the atmosphere bearings; gently rotate the bearing to distribute the lubricant.
- 3) Wipe away any excess lubricant and then reassemble the rotary drive.

If other maintenance or repairs are required, the unit should be returned to VACGEN service department.

## 3.0 The RD91M Rotary Drive

### 3.1 Specification

|                 |  |
|-----------------|--|
| Motor Type      | 23 Frame Size Stepper (23HS108) Wired coils in series  |
| Full Step Angle | 1.8° (200 steps per revolution)  |
| Half Step Angle | 0.9° preferred mode of operation (400 steps per revolution)  |
| Rail Voltage    | 50Vdc  |
| Coils in Series | 2.0Amp   |
| Speed           | 500rpm maximum at 3333 half steps per second   |
| Torque          | 28Ncm at 50rpm (333 half steps per second)<br>24Ncm at 500rpm For bakeout, the motor unit must be removed. |

|  |  |           |   |                  |
|--|--|-----------|---|------------------|
| <br><b>VACGEN</b> | DOCUMENT NAME<br><b>Operating and Maintenance Handbook - Rotary Drives<br/>RD9, RD91, RD91MG, RD91SB, RD93, RD932, RD93K,<br/>RD93P, RD94 RD942, RD94K</b> |           | VERSION<br>1.1                          | <b>UI32395A</b>  |
|  | FILE NAME<br>UI32395A  |           | REVISED DATE & INITIALS<br>May 1995 MJD |                  |
|  | APPROVED BY  | DATE<br>- | PREPARED BY<br>MJD                      | DATE<br>May 1995 |

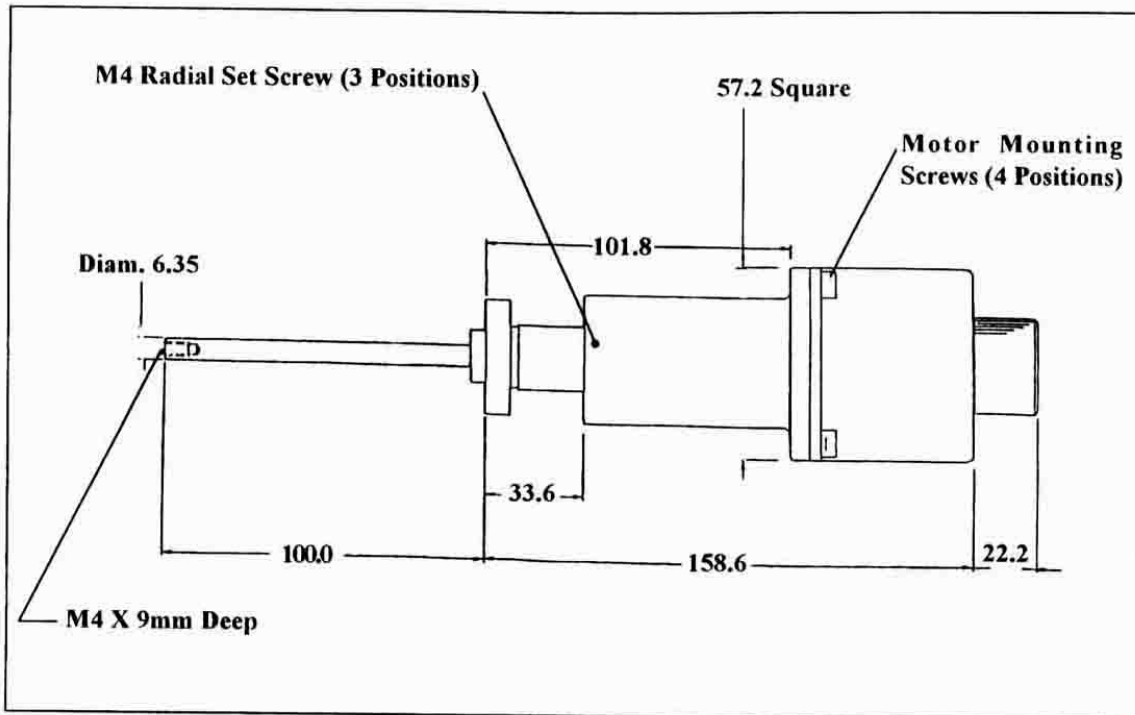

**Figure 2 - The RD91M rotary drive**

|                             |  |
|-----------------------------|--|
| Operating Pressure          | Atmosphere to $10^{-11}$ mbar  |
| Operating Temperature Range | -20°C to +40°C   |
| Bakeout Temperature         | 250°C maximum with motor drive removed<br>400°C maximum with further disassembly |
| Mounting Flange             | 34mm OD  |

### 3.2 Construction

The output shaft of the motor is concentrically mounted above the wobble bearing and attached by four screws to the black anodised body (see figure 2). The body is attached to the main bearing housing by three radial M4 set screws. Mounted on the output shaft of the motor is the drive fork which engages with the wobble bearing. The RD91M is supplied with flying leads to the motor; wiring details are given in figure 4.

Note: The bottom of the slot in the drive fork must be flush with the end of the motor shaft otherwise the fork will not correctly engage with the wobble bearing.



|   |   |              |                         |             |                 |
|---|---|--------------|-------------------------|-------------|-----------------|
|  | DOCUMENT NAME   |              |                         | VERSION     | <b>UI32395A</b> |
|   | <b>Operating and Maintenance Handbook - Rotary Drives<br/>RD9, RD91, RD91MG, RD91SB, RD93, RD932, RD93K,<br/>RD93P, RD94 RD942, RD94K</b> |              |                         | 1.1         |                 |
|   | FILE NAME   |              | REVISED DATE & INITIALS | REPLACEMENT |                 |
| UI32395A  |   | May 1995 MJD | -                       |             |                 |
| APPROVED BY   | DATE  | PREPARED BY  | DATE                    | PAGE        |                 |
|   | -   | MJD          | May 1995                | 92          |                 |

### 3.3 Operation

The RD91M rotary drive is capable of rotation speeds from 1/400 of a revolution (a 0.9° step) to 500rpm. VACGEN supply a range of stepper motor controllers to drive these devices (see section 7). The torque speed characteristics of the RD91M are shown in figure 3.

It is recommended that the stepper motor is driven in the half step mode; this will give a smoother and quieter drive than the full step mode. Backlash is minimal but inherent in this type of drive. For high precision repeatability it is recommended that the desired angular position is always approached from the same direction of rotation.

*Note: Stepper motors do become hot during normal operation.*

### 3.4 Bakeout

#### 3.4.1 Bakeout to 250°C

It is essential to demount the motor before starting bakeout. This is done by removing the four cap head screws that secure the motor to the body (see figure 2). In this state the rotary drive can be baked at up to 250°C.

When reassembling the motor to the drive, ensure that the drive fork is correctly aligned with the wobble bearing.

#### 3.4.2 High Temperature Bakeout to 400°C

To prepare the drive for bakeout at temperatures between 250°C and 400°C proceed as follows:

- 1) Remove the motor as described in section 3.4.1
- 2) Unscrew the three M4 radial set screws (2 to 3 turns) and remove the black anodized body.
- 3) Remove the circlip and the bearing from the end of the bellows.

The drive is now ready for bakeout at temperatures up to 400°C. After bakeout is complete, allow the drive to cool for 6-8 hours before reassembling the wobble bearing and motor drive.

To reassemble, follow the reverse procedure (steps 3 to 1 above).

Note:

If the drive is run whilst the internal vacuum components are still hot (from the bakeout), serious damage may occur.

|   |   |                         |          |                 |
|---|---|-------------------------|----------|-----------------|
|  | DOCUMENT NAME   |                         | VERSION  | <b>UI32395A</b> |
|   | <b>Operating and Maintenance Handbook - Rotary Drives<br/>RD9, RD91, RD91MG, RD91SB, RD93, RD932, RD93K,<br/>RD93P, RD94 RD942, RD94K</b> |                         | 1.1      |                 |
|   | FILE NAME   | REVISED DATE & INITIALS |          | REPLACE         |
| UI32395A  | May 1995 MJD  |                         | -        |                 |
| APPROVED BY   | DATE  | PREPARED BY             | DATE     | PAGE            |
|   | -   | MJD                     | May 1995 | 102             |

### 3.5 Maintenance

Little routine maintenance of the drive is required apart from occasionally checking that the various joining screws and the drive fork shaft screws are secure. Periodically it may be necessary to renew the lubricant in the wobble bearing. To do this, proceed as follows:

- 1) Remove the motor.
- 2) Unscrew the three M4 radial set screws (2-3 turns) and remove the black anodized body, taking care not to damage the bellows.
- 3) Apply a small amount of Carbaflo lubricant (ZHPTSLK lubrication kit) to the wobble bearing. Gently rotate the bearing to distribute the lubricant; wipe off any excess.
- 4) Reassemble the drive.

If other maintenance or repairs are required, the unit should be returned to VACGEN service department.

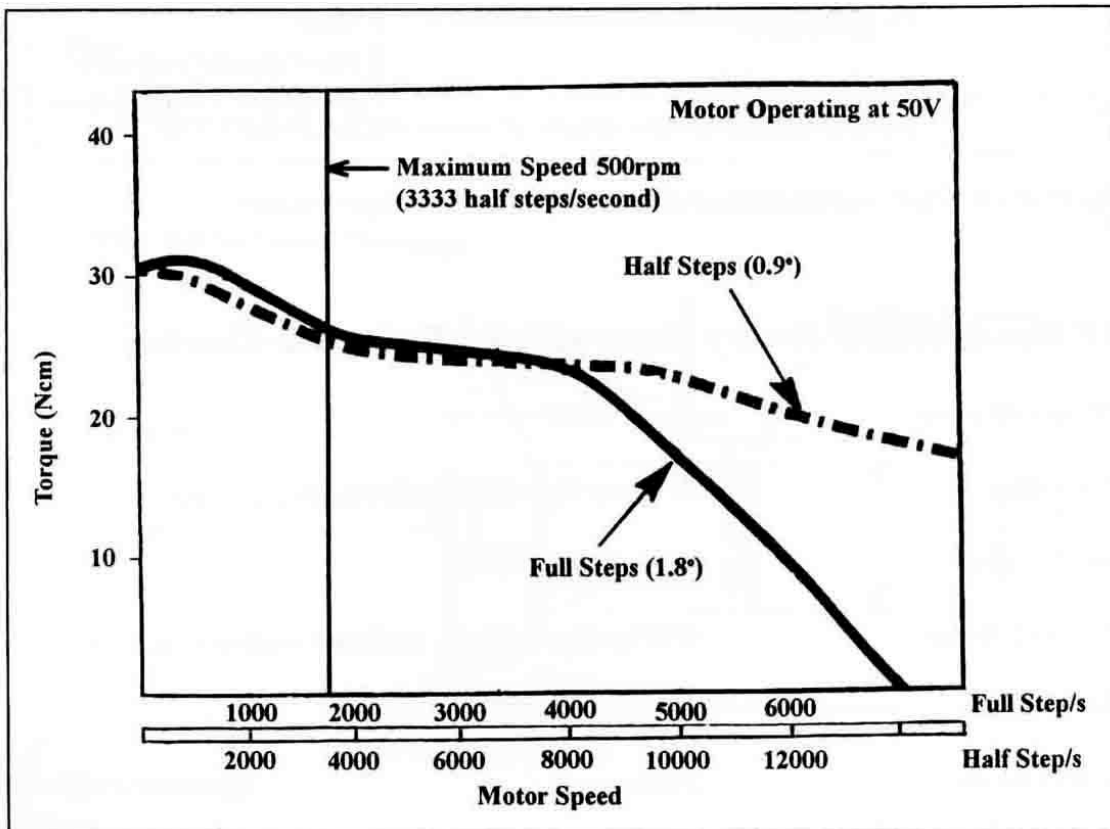

Figure 3 - The torque speed performance of the RD91M rotary drive



|  |                       |                 |   |                    |                  |
|--|-----------------------|-----------------|---|--------------------|------------------|
| DOCUMENT NAME<br><b>Operating and Maintenance Handbook - Rotary Drives<br/>         RD9, RD91, RD91MG, RD91SB, RD93, RD932, RD93K,<br/>         RD93P, RD94 RD942, RD94K</b> | VERSION<br>1.1        | <b>UI32395A</b> |   |                    |                  |
|  | FILE NAME<br>UI32395A |                 | REVISED DATE & INITIALS<br>May 1995 MJD | REPLACEMENT<br>-   | CLASSIFICATION   |
|  | APPROVED BY           |                 | DATE<br>-                               | PREPARED BY<br>MJD | DATE<br>May 1995 |

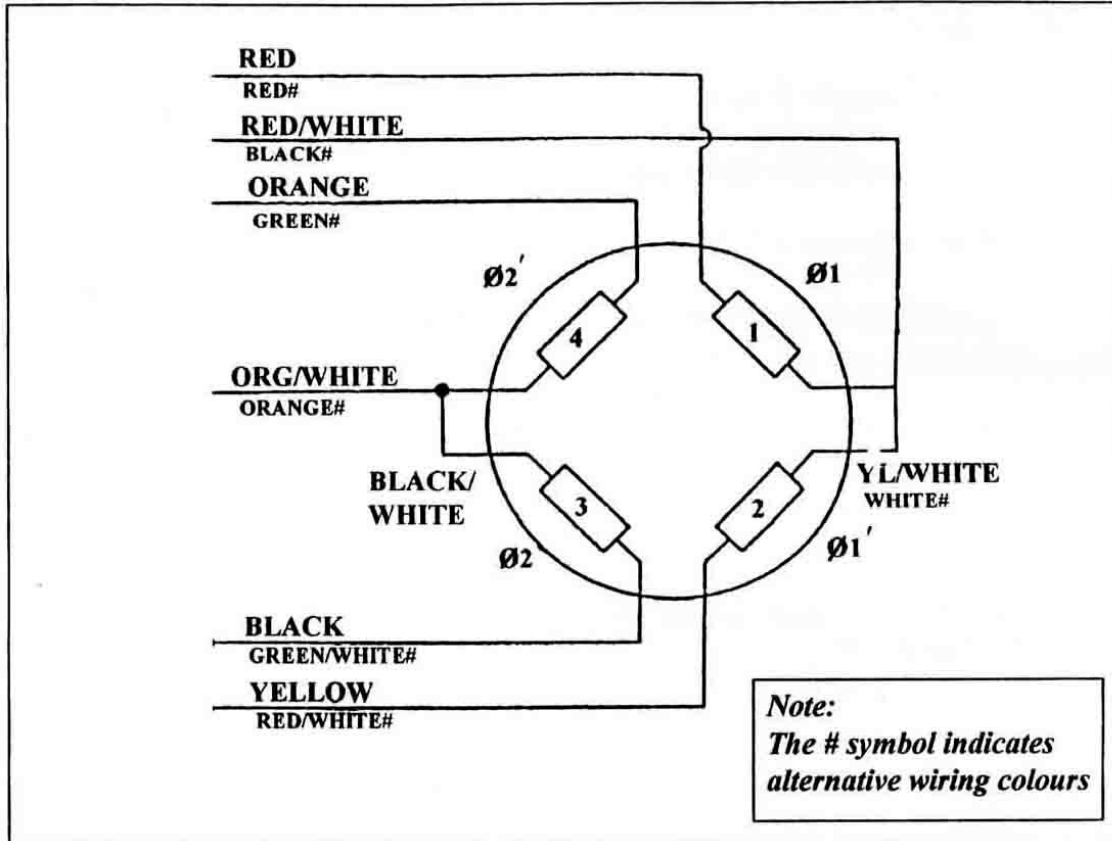



Figure 4 - The series wiring diagram for the 23 frame size stepper motor

#### 4.0 The RD9IMG Rotary Drive with 5:1 Reduction Gearbox

##### 4.1 Specification

|                             |   |
|-----------------------------|---|
| Motor Type                  | 23 Frame Size (23HS108) wired coils in series       |
| Full Step Angle             | 0.36° at Output Shaft                               |
| Half Step Angle             | 0.18° at Output Shaft - preferred mode of operation |
| Rail Voltage                | 50Vdc   |
| Coils in Series             | 2.0Amp  |
| Output Speed                | 300rpm maximum at 10,000 half steps per second      |
| Torque                      | 50Ncm at 300rpm                                     |
| Operating Pressure          | Atmosphere to 10 <sup>-11</sup> mbar                |
| Operating Temperature Range | -20°C to +40°C                                      |

|   |   |              |                         |                 |
|---|---|--------------|-------------------------|-----------------|
|  | DOCUMENT NAME   |              | VERSION                 | <b>UI32395A</b> |
|   | <b>Operating and Maintenance Handbook - Rotary Drives<br/>RD9, RD91, RD91MG, RD91SB, RD93, RD932, RD93K,<br/>RD93P, RD94 RD942, RD94K</b> |              | 1.1                     |                 |
|   | FILE NAME   |              | REVISED DATE & INITIALS | REPLACEMENT     |
| UI32395A  |   | May 1995 MJD | -                       |                 |
| APPROVED BY   | DATE  | PREPARED BY  | DATE                    | PAGE            |
|   | -   | MJD          | May 1995                | 122             |

Bakeout Temperature            250°C maximum with motor drive and gearbox removed  
400°C maximum with further disassembly

Mounting Flange                34mm OD

## 4.2 Construction

The output shaft of the gearbox is concentrically mounted above the wobble bearing and attached by four screws to the black anodised body (see figure 5). The body is attached to the main bearing housing by three radial M4 set screws. Mounted on the output shaft of the gearbox is the drive fork which engages with the wobble bearing. The RD91MG is supplied with flying leads to the motor; wiring details are given in figure 4.

Note:

The bottom of the slot in the drive fork must be flush with the end of the gearbox shaft otherwise the fork will not correctly engage with the wobble bearing.

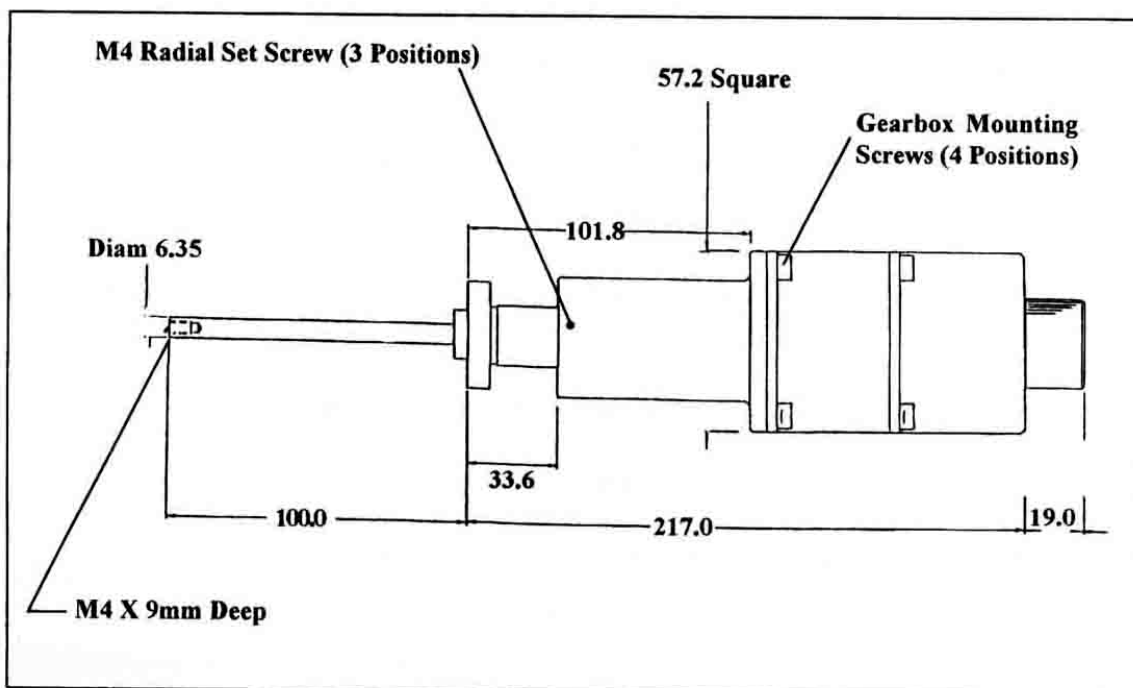



Figure 5 - The RD91MG Rotary Drive

|   |   |              |                         |      |         |                 |
|---|---|--------------|-------------------------|------|---------|-----------------|
|  | DOCUMENT NAME   |              |                         |      | VERSION | <b>UI32395A</b> |
|   | <b>Operating and Maintenance Handbook - Rotary Drives<br/>RD9, RD91, RD91MG, RD91SB, RD93, RD932, RD93K,<br/>RD93P, RD94 RD942, RD94K</b> |              |                         |      | 1.1     |                 |
|   | FILE NAME   |              | REVISED DATE & INITIALS |      | REPLACE |                 |
| UI32395A  |   | May 1995 MJD |                         | -    |         |                 |
| APPROVED BY   | DATE  | PREPARED BY  | DATE                    | PAGE |         |                 |
|   | -   | MJD          | May 1995                | 132  |         |                 |

### 4.3 Operation

The RD91MG rotary drive is capable of rotation speeds from 1/2000 of a revolution (a 0.09° half step) to 300rpm. VACGEN supplies a range of stepper motor controllers to drive these devices (see section 7).

It is recommended that the stepper motor is driven in the half step mode; this will give a smoother and quieter drive than the full step mode. Backlash is minimal but inherent in this type of drive. For high precision repeatability it is recommended that the desired angular position is always approached from the same direction of rotation.

Note: Stepper motors do become hot during normal operation.

### 4.4 Bakeout

#### 4.4.1 Bakeout to 250°C

It is essential to demount the gearbox before starting bakeout; the motor should be left attached to the gearbox. This is done by removing the four cap head screws that secure the gearbox to the body (see figure 5). In this state the rotary drive can be baked at up to 250°C. When reassembling the gearbox to the drive, ensure that the drive fork is correctly aligned with the wobble bearing.

#### 4.4.2 High Temperature Bakeout to 400°C

To prepare the drive for bakeout at temperatures between 250°C and 400°C proceed as follows:

- 1) Remove the gearbox as described in section 4.4. 1.
- 2) Unscrew the three M4 radial set screws (2 to 3 turns) and remove the black anodized body.
- 3) Remove the circlip and the bearing from the end of the bellows.

The drive is now ready for bakeout at temperatures up to 400°C. After bakeout is complete, allow the drive to cool for 6-8 hours before reassembling the wobble bearing and motor drive.

To reassemble, follow the reverse procedure (steps 3 to 1 above).

Note:

If the drive is run whilst the internal vacuum components are still hot (from the bakeout), serious damage may occur.

|   |   |              |                         |      |         |                 |
|---|---|--------------|-------------------------|------|---------|-----------------|
|  | DOCUMENT NAME   |              |                         |      | VERSION | <b>UI32395A</b> |
|   | <b>Operating and Maintenance Handbook - Rotary Drives<br/>RD9, RD91, RD91MG, RD91SB, RD93, RD932, RD93K,<br/>RD93P, RD94 RD942, RD94K</b> |              |                         |      | 1.1     |                 |
|   | FILE NAME   |              | REVISED DATE & INITIALS |      | REPLACE | CLASSIFICATION  |
| UI32395A  |   | May 1995 MJD |                         | -    |         |                 |
| APPROVED BY   | DATE  | PREPARED BY  | DATE                    | PAGE |         |                 |
|   | -   | MJD          | May 1995                | 142  |         |                 |

## 4.5 Maintenance

Little routine maintenance of the drive is required apart from occasionally checking that the various joining screws and the drive fork shaft screws are secure. Periodically it may be necessary to renew the lubricant in the wobble bearing. To do this, proceed as follows:

- 1) Remove the gearbox (with the motor still attached).
- 2) Unscrew the three M4 radial set screws (2-3 turns) and remove the black anodized body, taking care not to damage the bellows.
- 3) Apply a small amount of Carbaflo lubricant (ZHPTSLK lubrication kit) to the wobble bearing. Gently rotate the bearing to distribute the lubricant; wipe off any excess.
- 4) Reassemble the drive.

If other maintenance or repairs are required, the unit should be returned to VACGEN service department.

## 5.0 RD93 Miniature Rotary Drive

### 5.1 Specification

|                         |   |
|-------------------------|---|
| Rotation                | 360° continuous   |
| Speed                   | 300 rpm maximum   |
| Torque                  | 100Ncm at 10rpm<br>12Ncm at 300rpm                              |
| Thrust                  | 16N   |
| Shaft Tip Concentricity | 0.1mm T.I.R.  |
| Pressure Range          | atmosphere to $<10^{-11}$ mbar (positive external pressure)     |
| Bakeout Temperature     | 250°C maximum with drive assembled, 450°C with some disassembly |
| Operating Temperature   | -20°C to 200°C  |
| Mounting Flange         | RD93 - 34mm OD<br>RD932 - 70mm OD<br>RD93K - KF25 fitting       |

|   |   |                         |          |                 |
|---|---|-------------------------|----------|-----------------|
|  | DOCUMENT NAME   |                         | VERSION  | <b>UI32395A</b> |
|   | <b>Operating and Maintenance Handbook - Rotary Drives<br/>RD9, RD91, RD91MG, RD91SB, RD93, RD932, RD93K,<br/>RD93P, RD94 RD942, RD94K</b> |                         | 1.1      |                 |
|   | FILE NAME   | REVISED DATE & INITIALS | REPLACE  | CLASSIFICATION  |
| UI32395A  | May 1995 MJD  | -                       |          |                 |
| APPROVED BY   | DATE  | PREPARED BY             | DATE     | PAGE            |
|   | -   | MJD                     | May 1995 | 152             |

## 5.2 Construction

The RD93 drive is shown in figure 6. The vacuum envelope, and all parts within the vacuum enclosure, is constructed from stainless steel; all joints are welded. All other parts are constructed from anodised aluminum, or from stainless steel. All the moving parts are constrained by ball bearings. The input and output shafts are stainless steel. The outer casing is secured to the body by three M4 radial set screws; removing these screws allows the outer casing, together with the bellows end bearing, to be removed. The mounting flange is a 34mm OD knife edge flange - 70mm OD and KF25 mounting flanges are also available.

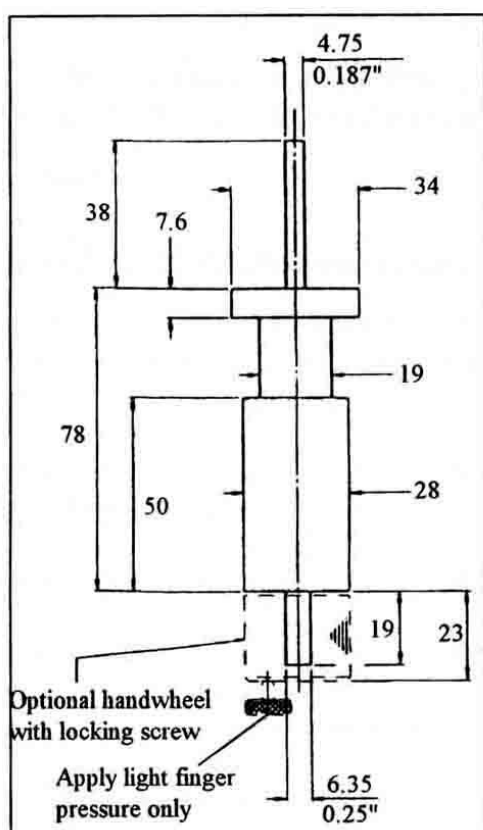

Figure 6 - The RD93 rotary drives

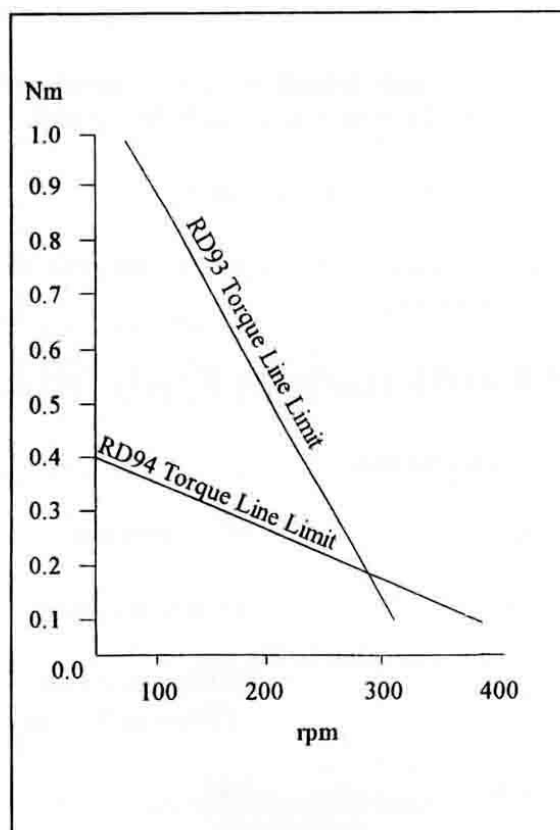



Figure 7. RD93 and RD94 torque-speed graphs

## 5.3 Operation

The standard drive is supplied for manual operation. The handwheel is easily removed (by means of a grub screw) to enable the shaft to be directly coupled to a drive system. The load torques on the drive must be kept below the torque line shown in figure 7. No maintenance is required; all bearings have been lubricated for life. The maximum bakeout temperature of the RD93 drive is 250°C fully assembled. This may be increased to 450°C if the top cap and the outer casing (together with the bellows end bearing) are removed - see section 5.2.

|   |   |              |                         |                 |
|---|---|--------------|-------------------------|-----------------|
|  | DOCUMENT NAME   |              | VERSION                 | <b>UI32395A</b> |
|   | <b>Operating and Maintenance Handbook - Rotary Drives<br/>RD9, RD91, RD91MG, RD91SB, RD93, RD932, RD93K,<br/>RD93P, RD94 RD942, RD94K</b> |              | 1.1                     |                 |
|   | FILE NAME   |              | REVISED DATE & INITIALS | REPLACE         |
| UI32395A  |   | May 1995 MJD | -                       |                 |
| APPROVED BY   | DATE  | PREPARED BY  | DATE                    | PAGE            |
|   | -   | MJD          | May 1995                | 162             |

## 6.0 RD94 Miniature Rotary Drive with Graduated Handwheel

### 6.1 Specification

|                         |  |
|-------------------------|--|
| Rotation                | 360° continuous  |
| Speed                   | 400 rpm maximum  |
| Torque                  | 40Ncm at 10rprn<br>12Ncm at 400rpm   |
| Thrust                  | 16N  |
| Shaft Tip Concentricity | 0.1mm T.T.R.   |
| Pressure Range          | 1 atmosphere to $<10^{-11}$ mbar (positive external pressure)                                  |
| Bakeout Temperature     | 250°C maximum width drive assembled<br>450°C with outer casing and bellows end bearing removed |
| Operating Temperature   | -20°C to 200°C   |
| Mounting Flange         | 34mm OD and 70mm OD knife edge flange, KF25 Klein fitting                                      |

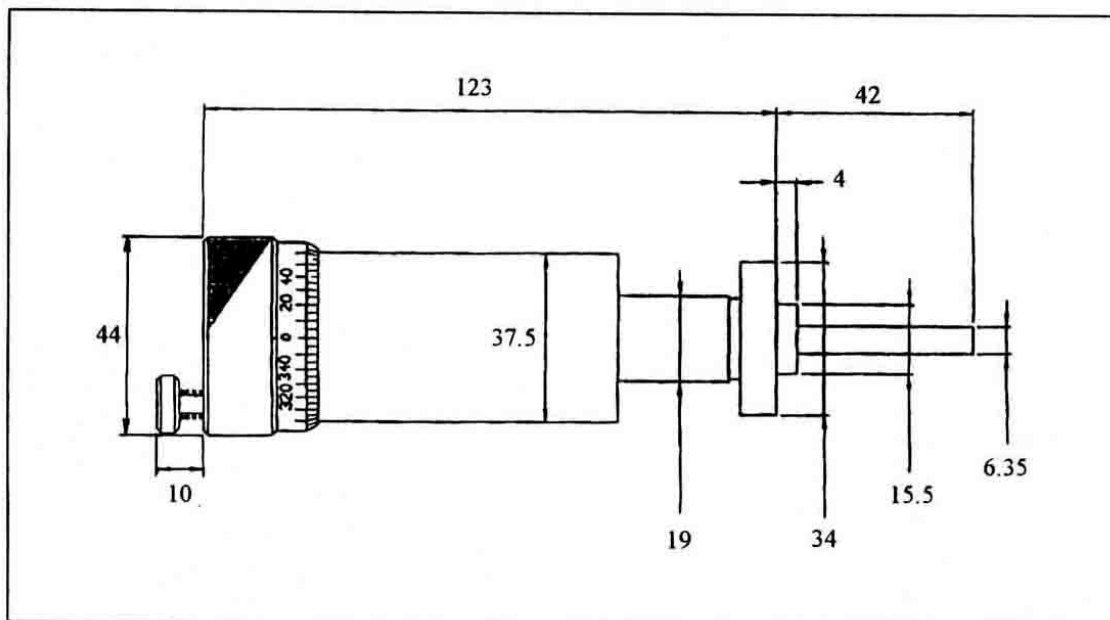



Figure 8 - The RD94 Rotary Drive



|   |   |              |                         |      |             |                 |
|---|---|--------------|-------------------------|------|-------------|-----------------|
|  | DOCUMENT NAME   |              |                         |      | VERSION     | <b>UI32395A</b> |
|   | <b>Operating and Maintenance Handbook - Rotary Drives<br/>RD9, RD91, RD91MG, RD91SB, RD93, RD932, RD93K,<br/>RD93P, RD94 RD942, RD94K</b> |              |                         |      | 1.1         |                 |
|   | FILE NAME   |              | REVISED DATE & INITIALS |      | REPLACEMENT |                 |
| UI32395A  |   | May 1995 MJD |                         | -    |             |                 |
| APPROVED BY   | DATE  | PREPARED BY  | DATE                    | PAGE |             |                 |
|   | -   | MJD          | May 1995                | 172  |             |                 |

## 6.2 Construction

The RD94 drive is shown in figure 8. The vacuum envelope, and all parts within the vacuum enclosure, are constructed from stainless steel; all joints are welded. All other parts are constructed from anodised aluminium, or from stainless steel. All the moving parts are constrained by ball bearings. The input and output shafts are stainless steel. The outer case is secured by three M4 radial set screws to the body flange assembly. The mounting flange is a 34mm OD knife edge flange - 70mm OD and KF25 mounting flanges are also available.

## 6.3 Operation

The standard drive is supplied for manual operation, it has a 511 graduated handwheel. This is easily removed (by means of a grub screw) to enable the shaft to be directly coupled to a drive system. No maintenance is required; all bearings have been lubricated for life.

The load torques on the drive must be kept below the torque line shown in figure 7.

The bakeout temperature of the fully assembled RD94 drive is 250°C. This may be increased to 450°C if the top cap and the outer casing (together with the bellows end bearing) are removed - see section 6.2.

## 7.0 Spares and Accessories

### 7.1 The RD91 Friction Brake Accessory - RD91SB

The adjustable friction brake (see figure 9) can only be fitted to the Mk 11 RD91 rotary drive; the device is not available for the RD91M or RD91MG variants. The brake slip torque range is from 0 to 0.5Nm. Applications range from simply providing a low friction drag to stop unwanted accidental movement, to supporting loads that might otherwise cause the drive to rotate or 'runaway'. For example the RD91SB can be used for the support of a vertically mounted rack gear with its drive pinion mounted horizontally on the RD91 shaft. The friction brake enables the rack to be left in various positions along its travel, without the weight of the rack causing runaway of the drive. The original drive position lock cannot be used with the friction accessory. The accessory is bakeable to 250°C - the friction drag torque is likely to change after bakeout.

#### 7.1.1 Fitting the Friction Brake to the RD91 Rotary Drive

1. Remove the RD91 from the vacuum system
2. Remove the drive handwheel and position lock ring from the drive as described in section 2.3.2 (items 1 through 5 only).
3. Place the drive on a work surface such that the three fixing screws are uppermost.
4. Slacken the two M4 friction adjustment screws (item 4 on figure 9) such that the friction pad (item 3) is flush with the edge of its housing.
5. Remove the clamp screw (item 1). Insert the friction assembly (friction pad uppermost) over the rotary drive handwheel. It may be necessary to spring open the housing (a screwdriver inserted within the split can be used as a wedge).

|   |   |                         |          |                 |
|---|---|-------------------------|----------|-----------------|
|  | DOCUMENT NAME   |                         | VERSION  | <b>UI32395A</b> |
|   | <b>Operating and Maintenance Handbook - Rotary Drives<br/>RD9, RD91, RD91MG, RD91SB, RD93, RD932, RD93K,<br/>RD93P, RD94 RD942, RD94K</b> |                         | 1.1      |                 |
|   | FILE NAME   | REVISED DATE & INITIALS |          | REPLACE         |
| UI32395A  | May 1995 MJD  |                         | -        |                 |
| APPROVED BY   | DATE  | PREPARED BY             | DATE     | PAGE            |
|   | -   | MJD                     | May 1995 | 182             |

6. Place the ring (item 2) over the rotary drive bellows, and park it next to the flange. Note that the radius edge of the ring must be next to the flange.

7. Reassemble the combined friction rotary drive handle to the rotary drive. Ensure that the bellows bearing offset is correctly aligned within the handwheel slot. Tighten the three M4 set screws.

8. Locate the ring (item 2) over the handwheel boss and set a gap of 0.1 - 0.3mm between it and the handwheel. Tighten the three ring fixing screws.

9. Set a 0.5 - 1.0mm gap between the ring (item 2) and the easing; tighten the easing clamp screw (item 1).

10. Set the required friction drag by adjusting the friction adjustment screws (item 4). Tighten up by half a turn per screw until the required drag torque is achieved.

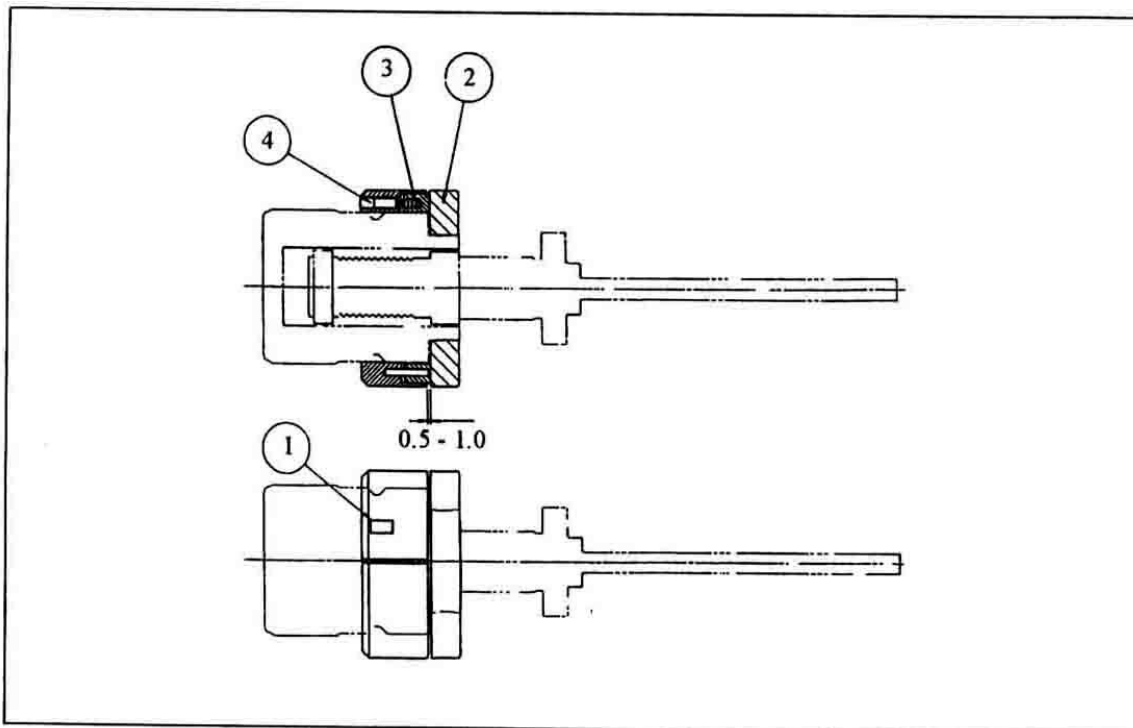

**Figure 9 - The RD91SB friction brake accessory**

|   |   |                         |             |                 |
|---|---|-------------------------|-------------|-----------------|
|  | DOCUMENT NAME   |                         | VERSI<br>ON | <b>UI32395A</b> |
|   | <b>Operating and Maintenance Handbook - Rotary Drives<br/>RD9, RD91, RD91MG, RD91SB, RD93, RD932, RD93K,<br/>RD93P, RD94 RD942, RD94K</b> |                         | 1.1         |                 |
|   | FILE NAME   | REVISED DATE & INITIALS | REPLA<br>CE | CLASSIFICATION  |
| UI32395A  | May 1995 MJD  | -                       |             |                 |
| APPROVED BY   | DATE  | PREPARED BY             | DATE        | PAGE            |
|   | -   | MJD                     | May 1995    | 192             |

## Service and Repair Form

|   |  |
|---|--|
| Declaration of Contamination of Equipment and Components  |  |
| <p>Servicing and repairs will only be carried out if the conditions for Servicing and Repair are complied with in full, according to the VACGEN Ltd. Conditions of Sale. A summary of these requirements are included on the inside front cover of the Operating Instructions. The manufacturer will refuse to accept any equipment without a signed declaration attached to the OUTSIDE of the packaging. This declaration can only be completed and signed by authorized and qualified staff.</p> |  |
| <b>1 Description of Equipment and Components</b>  |  |
| Equipment Type.....Model Number.....<br>Serial Number..... Your Reference Number.....   |  |
| <b>2 Reasons for return</b> .....   |  |
| .....   |  |
| .....   |  |
| <b>3 Condition of Equipment</b>   |  |
| YES ( ) NO ( ) Toxic?   | YES ( ) NO ( ) Corrosive?                |
| YES ( ) NO ( ) Explosive?   | YES ( ) NO ( ) Biological Hazard?        |
| YES ( ) NO ( ) Radioactive?   | YES ( ) NO ( ) Other Harmful Substances? |
| Equipment and Components that have been contaminated, WILL NOT be accepted without written evidence of decontamination.   |  |
| <b>5 Contamination Materials</b>  |  |
| List all the substances, gases and by-products that may have come in contact with the equipment, giving trade name, manufacture, chemicals names or symbols.<br>Please note that any of these listed, must be completely removed, so it is safe to handle and weld, without giving off health threatening gases. Please enter details below and/or attach data sheets<br>.....<br>.....<br>.....  |  |
| <b>6 Legally Binding Declaration</b>  |  |
| I hereby declare that the information supplied on this form is complete and accurate.<br>There by stating that the goods offer no risk to health or safety<br>Organisation..... Name.....<br>Country..... Job Title.....<br>Post/ZIP code..... Telephone.....<br>Email.....<br>Signature..... Date.....   |  |
| Return goods to: VACGEN, Diamond Drive, Hailsham, BN27 4EL, UK – 01323 379335<br>(Form VGF33)   |  |

|  |   |              |                         |      |             |                 |
|--|---|--------------|-------------------------|------|-------------|-----------------|
| <br><b>VACGEN</b> | DOCUMENT NAME   |              |                         |      | VERSION     | <b>UI32395A</b> |
|  | <b>Operating and Maintenance Handbook - Rotary Drives<br/>RD9, RD91, RD91MG, RD91SB, RD93, RD932, RD93K,<br/>RD93P, RD94 RD942, RD94K</b> |              |                         |      | 1.1         |                 |
|  | FILE NAME   |              | REVISED DATE & INITIALS |      | REPLACEMENT | CLASSIFICATION  |
| UI32395A   |   | May 1995 MJD |                         | -    |             |                 |
| APPROVED BY  | DATE  | PREPARED BY  | DATE                    | PAGE |             |                 |
|  | -   | MJD          | May 1995                | 22/2 |             |                 |

## Notes Page